

Motic[®]

MORE THAN MICROSCOPY



IND

BA310POL SERIES

ADVANCED POLARIZATION MICROSCOPE



CONTENTS BA310POL CATALOGUE

INTRODUCTION	02
THE MECHANICS	04
THE OPTICS	06
THE ILLUMINATION	08
DOCUMENTATION	10
SPECIFICATIONS	12

The BA310POL is a powerful Polarization microscope for transparent specimens of diverse origin. Fully integrated in Motic's BA family of Upright microscopes, this microscope is especially meant for the examination of birefringent samples from petrography and mineralogy, but can also be used for synthetic materials like foils or fibers from industrial production. The BA310POL also works well in Educational environments of material professions, where affordability and ease of use is a key issue.

A reliable Polarization microscope has to fulfill unique demands dictated by the sample characteristics. Careful attention has to be paid on strain-free optical components as well as smooth rotation of the circular stage. Following Motic's newest developments of lead-free manufacturing in full compliance with RoHS regulations, the strain-free versions of the new EC Plan Achromatic lenses naturally provide optimal image quality through a multi-layer lens coating. With crossed polarizer/analyzer, a dark image background is ensured.

The pre-centered rotating stage has got a hard coated and chemical resistant surface, while a high precision ball-bearing mechanism ensures smooth rotation. The built-in 30W light source is part of a Full Koehler setup for optimized image contrast by reducing stray light. The Intermediate Tube, an integral part of the standard microscope package, carries a Bertrand lens, both focusable and centerable.

As a standard, an anti-fungus treatment has been applied to the complete microscope to ensure a long lifetime of both microscope mechanics and optics in humid environments.

Your Motic Europe Team



BA310POL

ADVANCED POLARIZATION MICROSCOPE



THE MECHANICS

STAND & STAGE | EYEPIECE TUBES



INTRODUCTION

THE MECHANICS

THE OPTICS

THE ILLUMINATION

DOCUMENTATION

SPECIFICATIONS



SMOOTH MOVEMENT AND PRECISE POSITIONING

The BA310POL microscope stand carries a pre-centered stage with a hard coated surface to withstand abrasion even under rough usage. A high precision ball-bearing mechanism ensures a smooth rotation for a precise positioning of the sample. The fully rotatable polarizer is fixed to the sub-stage condenser carrier.

The ball bearing 4-fold nosepiece shows a reversed orientation. In reference to a given objective position, all other objectives can be centered individually. All eyepiece tubes allow the mounting of the crosshair eyepiece both in orthogonal and diagonal cross position.

Incorporating an interpupillary distance of 55-75mm, the BA310POL observation tubes guarantee hours of fatigue-free viewing. Digital documentation through the photo port of both trinocular tubes is possible with a 100:0/20:80 light split.

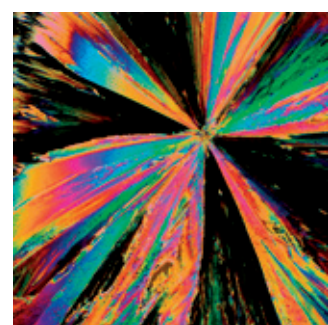
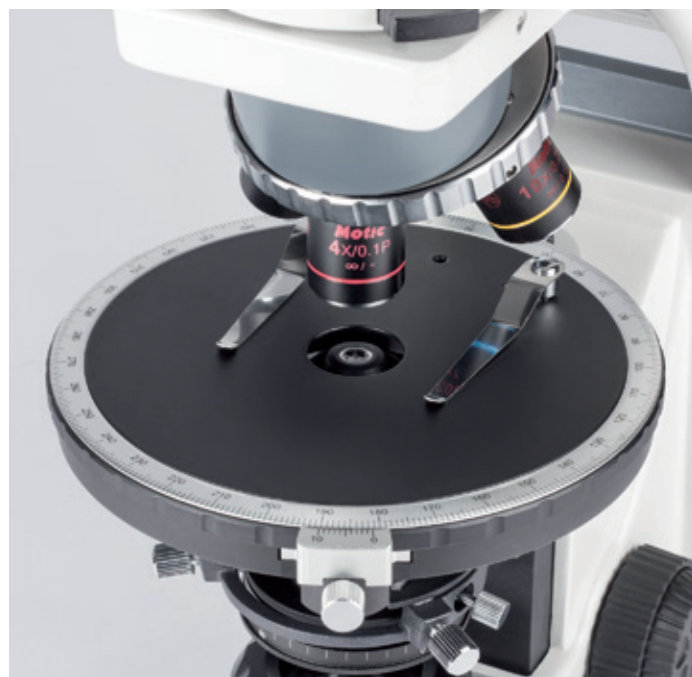

THE OPTICS

OBJECTIVES | EYEPIECES | INTERMEDIATE TUBE



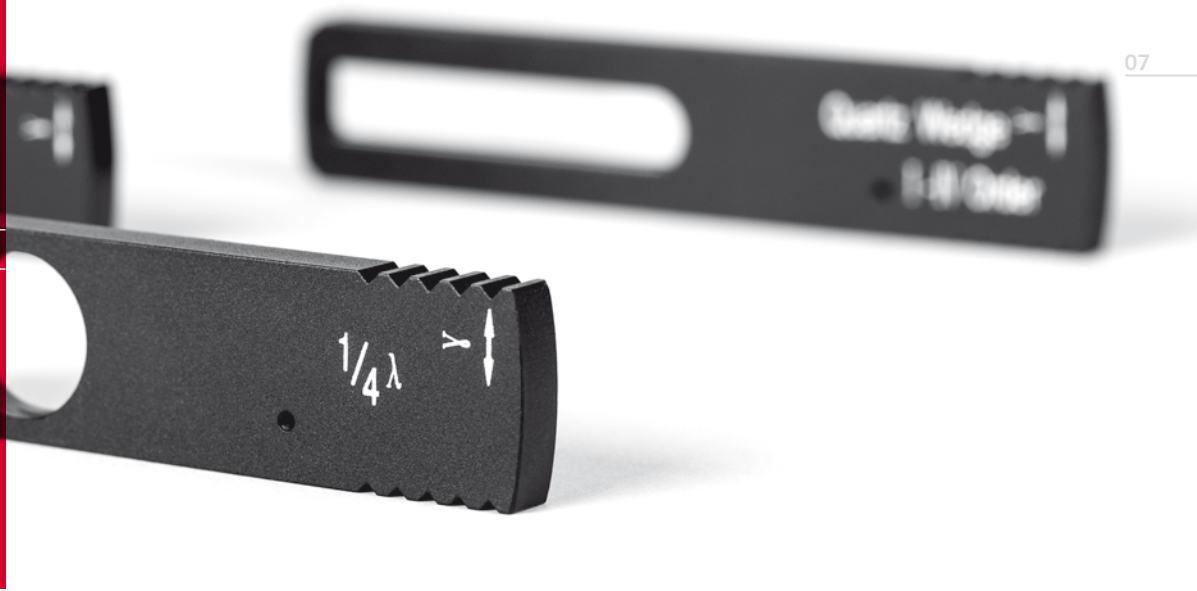

EC PLAN ACHROMATS AND CONOSCOPIC TOOLS

For the specific demands of the BA310POL microscope, Motic introduced a set of strain-free EC Plan Achromatic objectives. Following the CCIS® concept, these objectives are made of high quality glass with multi-layer coating for better contrast. The tube lens provides a completely corrected intermediate image with photo port for high quality documentation. Further objectives from Motic's BA series may also be used, keeping the minimized degree of extinction in mind.

The standard high eyepoint eyepieces N-WF 10X/20mm provide consistent diopter adjustment for both eyes. As required for polarization work, one eyepiece is equipped with a fixed crosshair reticle.

As an integral part of the BA310POL packages, the Intermediate tube carries a Bertrand lens, both focusable and centerable, and additionally the analyzer, thus revealing conoscopic information of crystal substructures. Moreover, a built-in slot allows the use of optional retardation and compensator sliders. The first order (also known as full wave or λ plate) retardation plate certainly will be most interesting, while the use of Quarter-wave retardation plate ($1/4 \lambda$) and Quartz wedge compensator plate are less common.



THE ILLUMINATION

LIGHT SOURCE | CONDENSER



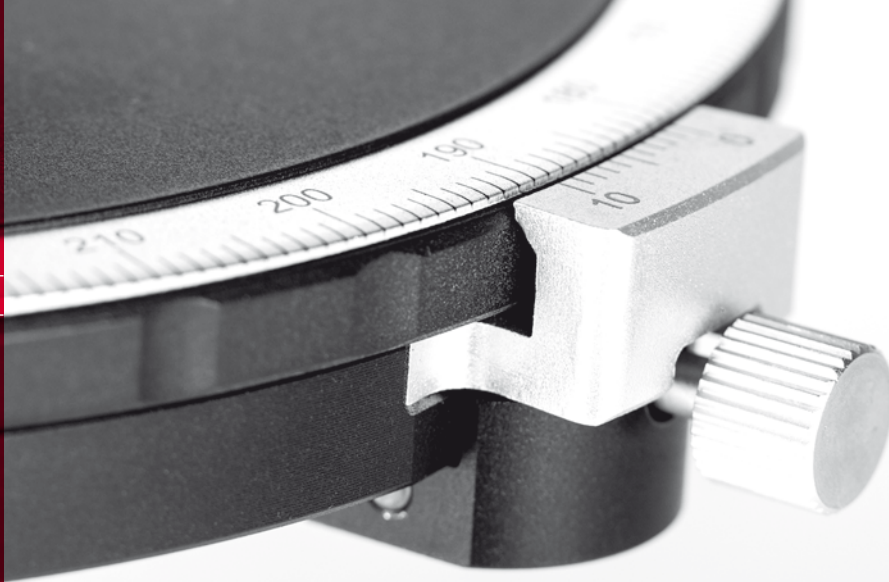

FLEXIBLE ILLUMINATION

The Transmitted illumination is based on a 30W Halogen light source. With an adjustable field diaphragm and aperture diaphragm, Full Koehler quality is given in terms of a homogenous illumination and reduced stray light. The Achromatic Swing-out condenser with N.A. 0.90/0.13 is strain-free and contributes to a darkest possible image background.

In case incident illumination is needed, the compatibility with Motic's BA310MET allows the replacement of the Intermediate tube by the Epi-Illuminator, at the same time requiring LM Plan objectives without cover glass correction. This setup is possible on special request.

BA310POL with Epi-Illuminator



DOCUMENTATION

STANDARD PHOTOMICROGRAPHY | DIGITAL DOCUMENTATION



INTRODUCTION
 THE MECHANICS
 THE OPTICS
 THE ILLUMINATION
DOCUMENTATION
 SPECIFICATIONS

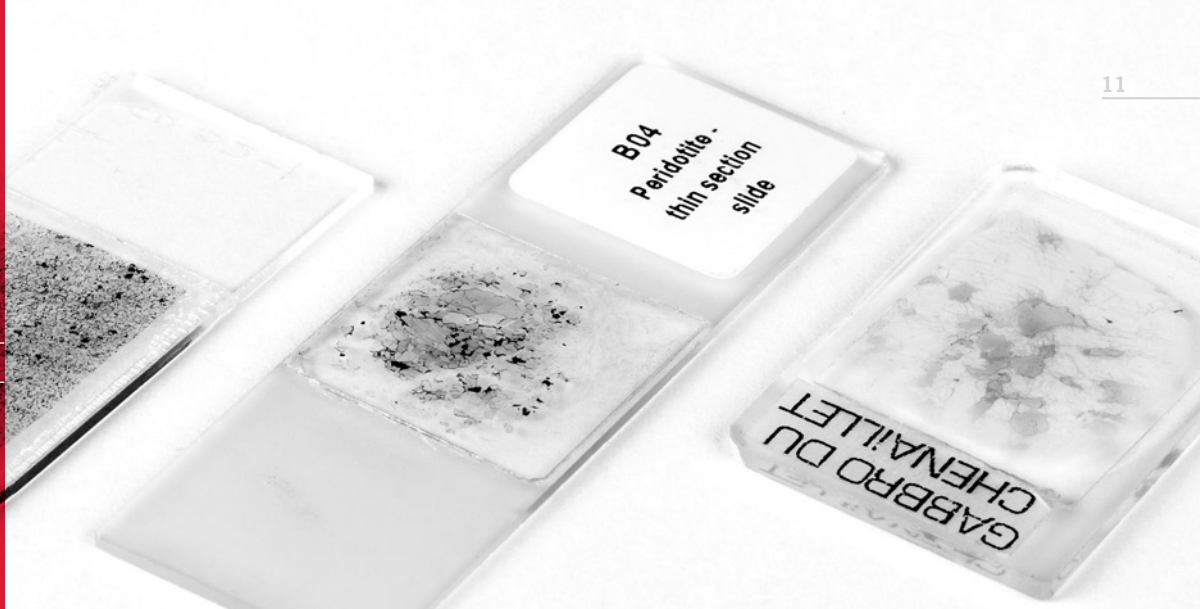

MULTIPLE DOCUMENTATION OPTIONS

Accurate documentation has been established as an essential part in natural sciences and industry. Like in all Motic's BA series, the new BA310POL offers the choice between several imaging options.

The traditional use of a single lens reflex camera requires the Trinocular version of the BA310POL. The adaptation of the camera consists of a mechanical adapter combined with a photo eyepiece (2.5X or 4X). The necessary T2 adapter specifically fits to the camera model and is supplied by photo specialist shops. This setup delivers high resolution images of small fields.

The Moticam series of digital c-mount cameras delivers excellent live images, ready for presentations and further storage. All Motic cameras come equipped with the new Motic Images Plus 3.0 proprietary software to transform the BA310POL into an analysis and documentation station.

Besides the standard USB cameras, which work through a computer, we offer solutions to fit with every user need. The new Moticam Full HD cameras are ideal for the presentation of High Resolution images on an HDMI screen without computer, as they can be easily controlled with the help of a mouse.

The Wi-Fi models are dedicated to run under tablet and smartphone control through our free "Moti-Connect" App, whereas the tablet cameras with touch screen in first instance work as a fixed monitor solution, but may also create a hotspot for remote tablet/smartphone access.

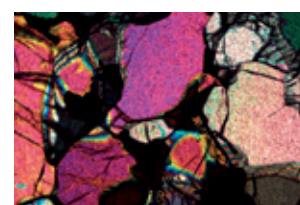
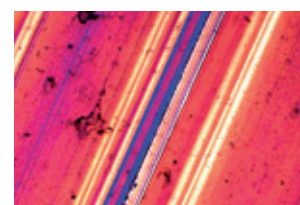

SPECIFICATIONS

BA310 POL STANDARD CONFIGURATION & OPTIONAL ACCESSORIES



General Specifications

Optional Configuration

Optical system	Color Corrected Infinity System CCIS®	
Observation system	30° inclination	
Interpupillary distance (mm)	55-75	
Eyepieces	N-WF 10X/20	
Diopter adjustment	+/- 5 dpt	
Reticles (25mm)	Crosshair in right eyepiece	Crosshair 10mm/100 divisions Crossed double scale 10mm/100 divisions
Trino light split	100:0/20:80	
Nosepiece	Reversed quadruple; 1 reference, 3 positions centrable	
Objective mounting thread RMS (W 4/5" X 1/36")	Yes	
EC Plan Achromat objectives	EC PL P 4X/0.10; 10X/0.25; 40X/0.65; 60X/0.8	EC PL P 20X/0.40
<i>Incident light objectives*</i>		<i>LM 5X/0.13; 10X/0.3; 20X/0.4; 50X/0.55; 100X/0.8; High NA EC-M PL 20X/0.45; 50X/0.75*</i>
Intermediate Tube	With Bertrand lens centrable/focusable, Compensator slot; Analyzer 360° rotatable and lockable	
Compensators		First Order RED (λ); λ/4; Quartz wedge 1-4 λ
Stage	360° rotatable, with 1° scale; lockable	
Stage size	160mm Ø	
Attachable x/y stage	Yes	Yes
Polarizer	On condenser carrier; 360° rotatable, 90° click-stop positions	
Focus	Brass gears; Z-axis movement 17mm; coaxial with tension adjustment	
Fine focus precision (µm)	2	
Upper limit stop	Preset, adjustable	
Transmitted light	6V/30W Halogen	
<i>Incident light*</i>		<i>Epi-Illuminator 50W*</i>
Condenser	Achromat swing out condenser NA 0.90/0.13; strain-free, with iris diaphragm	
Transformer	Internal	
Power supply	110-240V (CE)	
Filter holder	On top of light exit	
Filters	45mm Blue	45mm Green, Didymium, Neutral ND2
Dimensions (mm)	400 x 220 x 452	
Weight (kg)	10,4	
Contrast techniques		
Brightfield	Yes	
Darkfield	No	
DIC	No	
POL contrast	Yes	

* on special request

SPECIFICATIONS

BA310POL

SCHEMATIC DIAGRAMS & SYSTEM DIAGRAM (units: mm)

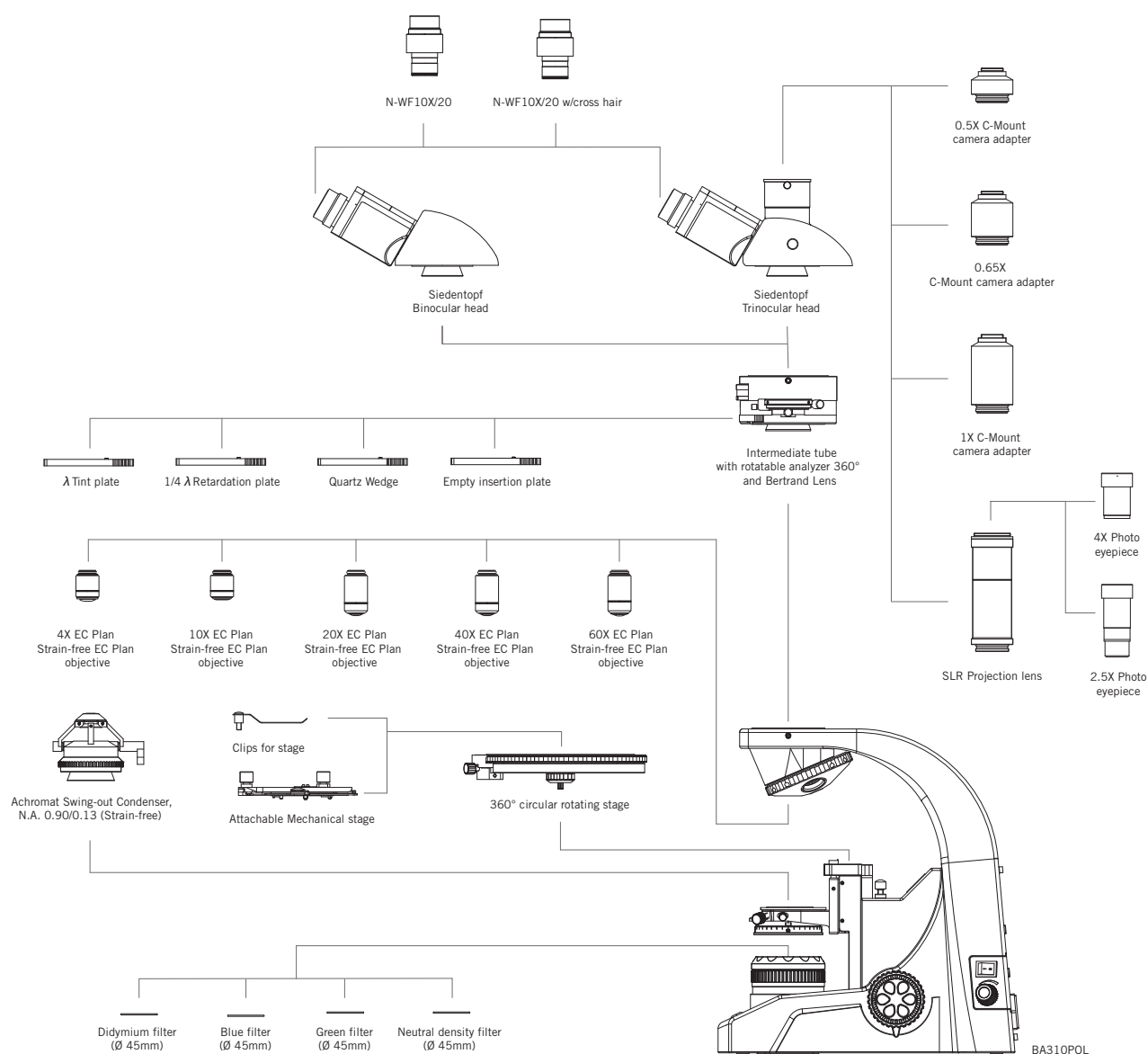
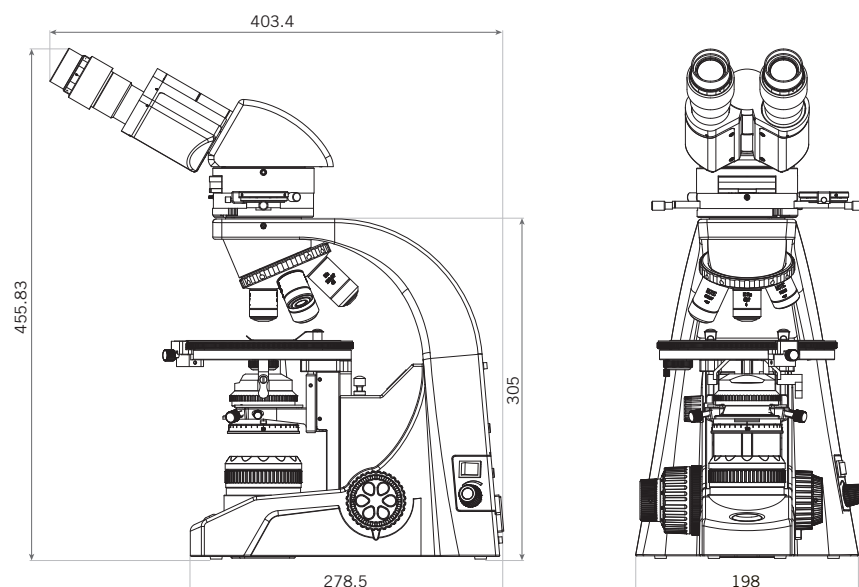

Motic®

Canada | China | Germany | Spain | USA



www.moticeurope.com

EN | ES | FR | DE | IT | PT

Motic Instruments (Canada)

130 - 4611 Viking Way. Richmond, BC V6V 2K9 Canada
Tel: 1-877-977 4717 | Fax: 1-604-303 9043

Motic Deutschland (Germany)

Christian-Kremp-Strasse 11, D-35578 Wetzlar, Germany
Tel: 49-6441-210 010 Fax: 49-6441-210 0122

Motic Hong Kong (Hong Kong)

Rm 2907-8, Windsor House, 311 Gloucester Road, Causeway Bay, Hong Kong
Tel: 852-2837 0888 | Fax: 852-2882 2792

Motic Europe (Spain)

C. Les Corts 12, Pol. Ind. Les Corts. 08349 Cabrera de Mar, Barcelona, Spain
Tel: 34 93 756 62 86 | Fax: 34 93 756 62 87

*CCIS® is a trademark of Motic Incorporation Ltd.

Motic Incorporation Limited Copyright © 2002-2019. All Rights Reserved.

Design Change: The manufacturer reserves the right to make changes in instrument design in accordance with scientific and mechanical progress, without notice and without obligation.

Designed in Barcelona (Spain)

Updated: December 2019



Official Distributor: